

Respect of customer, read the instructions carefully before you use manual!

USER MANUAL

■ Contents

Precautions for Use	02
Wiring Diagram	03
Remote Control	05
Front panel function and operation	06
Home Page Operation	08
Radio Operation	08
DVD Operation	09
USB/SD Operation	13
Navigation Operation	13
Bluetooth Operation	14
IPOD Operation	16
TV Operation	17
Virtual Six-Disc Operation	17
Clock Mode Operation	19
Calendar Operation	19
Calculator Operation	20
Game Interface Operation	21
System Setup	23
Troubleshooting	31
Performance Parameters	32



Please remove the two shockproof screws on the cover of the unit before installation!

■ Precautions for Use:

Thank you for choosing this product. If you take a few minutes to look through this manual and follow the following notices, you'll learn how to use all the features of your new unit for maximum enjoyment.

1. For the sake of your safety and avoiding violating the traffic rules, do not view Video or operate this unit while driving.
2. For the safety and normal use of this product, it is highly recommended that your unit is installed by a professional installer or an authorized dealer. Do not dismantle or repair the unit by yourself to avoid damage or accident.
3. Do not place the unit where it would be subject to moist or water splashing so as to avoid electric shock, damage, or even fire due to short circuits.
4. The TFT screen of this product is a precise electronic product, do not strike it with strong force in order to avoid damage or broken to the product.
5. Do not insert coin or other metal object into the unit.
6. Do not wipe the TFT screen with diluents or other chemical cleaner; instead wipe it with a soft cloth with the unit power off.
7. Do not expose this unit in direct sunlight for a long time.
8. Do not use irregular-shaped disc in this unit. (Only compact disk with 12CM in Diameter is supported).
9. Do not use a disc with stain or dust on it or a scratched or deformed disc.
10. Do not put the disc at a place where it would be subject to:
 - 1). Direct sunlight;
 - 2). Dirt, dust, or moist;
 - 3). Heat source like car heating pip;
 - 4). Seat or on dashboard.
11. Products of this company are constantly changing or upgrading. They are subject to change without further notice. Please refer to the actual functions of your product. Thanks for your understanding!



Note:

Please turn off the GPS navigation function before removing the GPS card. Any damage resulted from failure to follow instructions are not covered in the warranty of the company!

Wiring Diagram:

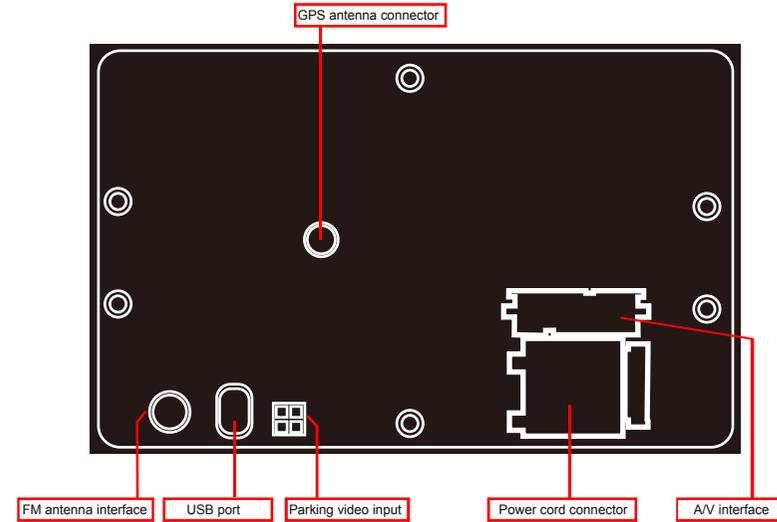

1. Definition of Power Cable Interfaces:

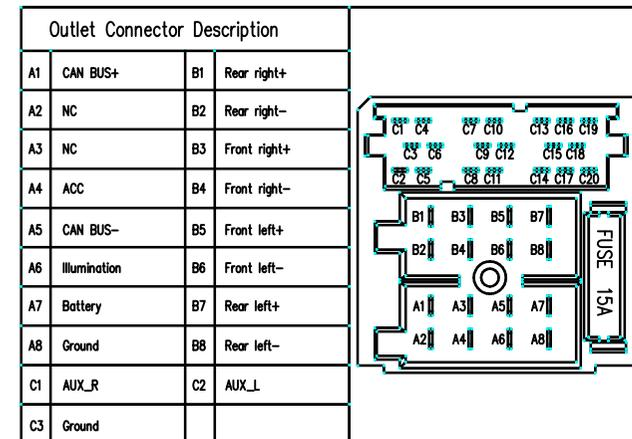

2. Definition of Audio/Video I/O Interfaces:

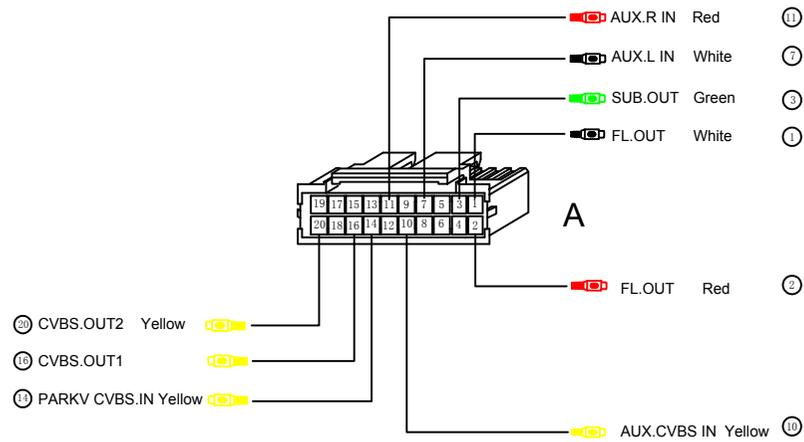

Remote Control:

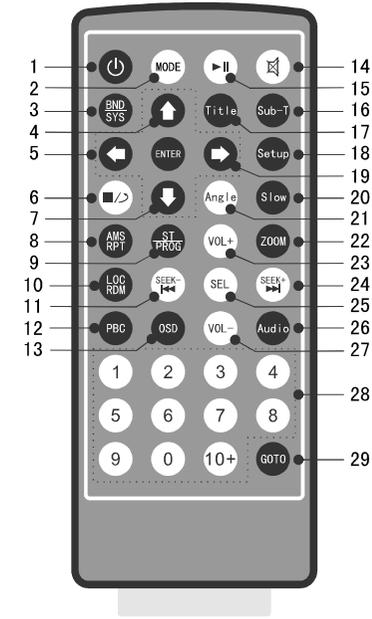

- | | |
|-----------------------------------|--------------------------------------|
| ① Backlight On/Off | ⑩ Subtitle (need supported by disc) |
| ② Mode | ⑪ Title |
| ③ Band/System Selection | ⑫ Touch screen calibration |
| ④ Up/ Tune Up | ⑬ Right/ Frequency Fine Tuning+ |
| ⑤ Left/Frequency Fine Tuning- | ⑭ Slow |
| ⑥ Stop | ⑮ Angle (needs supported by disc) |
| ⑦ Down/Tune Down | ⑯ Zoom in/out |
| ⑧ Auto Seek Channel/Repeat | ⑰ Volume+ |
| ⑨ Mono/stereo switch | ⑱ Next |
| ⑩ Local/remote switch/random play | ⑲ Sound effect, image parameter menu |
| ⑪ Previous | ⑳ Sound channel switch |
| ⑫ Playback Menu | ㉑ Volume - |
| ⑬ On Screen Display | ㉒ Numeric keys |
| ⑭ Mute | ㉓ Go to |
| ⑮ Play/Pause | |

Front panel function and operation:

Note:

This section introduces the front panel function of all models of the company. Please use them accordingly depending on the unit you purchased. Since the functions of product are constantly changing The description about functions may be a little different from your Unit. Please refer to the actual operational function of your unit.

1. PWR/MUTE: With unit off, press it momentarily to turn the unit on. With the unit on, press it momentarily to mute, press it long to turn the unit off.
2. ◀◀ (SEEK-): Select the previous track in DVD, SD, USB, IPOD mode, and the previous channel in TV, RADIO (FM/AM) mode.
3. ▶▶ (SEEK+): Select the next track in DVD, SD, USB, IPOD mode and the next channel in TV, and RADIO (FM/AM) mode.
4. ◀◀: Fast reverse in DVD, SD, USB, IPOD mode, frequency fine tuning - in TV mode.
5. ▶▶: Fast forward in DVD, SD, USB, IPOD mode, frequency fine tuning + in TV mode.
6. ▲: Press it momentarily to slide the screen angle up step by step; Long press it to continuously slide up to the end.
7. ▼: Press it momentarily to slide the screen angle down step by step; Long press it to continuously slide down to the end.
8. APS(AMP): Press it to search stations automatically in FM/AM and TV mode.
9. SNC(SCAN): Press it to scan the stored stations in FM/AM and TV mode.
10. MODE (SRC): Press this key to select between DVD, SD, IPOD, USB, RADIO, TV, BT, and AUX modes.
11. BAND: Press this key momentarily in radio mode to switch between bands; press it in other modes to enter the radio mode.
12. POWER(PWR): Press it momentarily to turn on/off the unit.

13. MUTE (): Press it to turn off the sound; press any key to turn on the sound.
14. ▶|| (PLAY/PAUSE): Play/pause key.
15. ▲ (EJ): Eject key, press it to insert/eject disc.
16. NAVI(GPS): Navigation shortcut, press it in any mode to enter the navigation mode.
17. EQ: Press it to select sound effect between Bass, Middle, or Treble or select equalization curves between POP, ROCK, CLASSIC, and others.
18. LOUD: Loudness adjustment, activating this feature will enhance the bass and treble frequencies when listening to music at low volumes and To make the loudness proportion at bass, middle and treble is the same as that at high volumes.
19. LCD-OFF: Press it to turn off the backlight and the TFT screen will black out.
20. MENU: Home page menu key, press it in any mode to return to the home page.
21. VOL+/VOL-: Volume up/down, press these two keys to adjust the volume up or down.
22. DVD: Press this key to enter DVD mode.
23. BT: Press this key to enter BT mode.
24. RADIO: Press it to enter the FM/AM mode.
25. MIC: BT microphone audio input window, the distance between this location and the sound source must not exceed 30CM, or the BT speech quality may be affected.
26. IPOD: IPOD interface, connect to IPOD unit.
27. IR: remote control receiving window.
28. : USB interface, insert USB cable to connect USB device.
29. RES: system reset key, press it to restore the default factory settings.

Home Page Operation:

Touch the mode icons on the home page to enter the corresponding function modes. The specific operations for entering each mode are described in the sections below. Touch and slide the home page to switch between home pages. Press the Mode key on the front panel or the remote control to select modes between AM/FM,DVD, USB,SD,TV,IPOD,and AVIN.

 : Touch it to silence the audio, touch it again to cancel.

 : Touch it to turn off the backlight and the screen will black out.

Radio Operation:

Click the Radio key on the front panel or touch the Radio icon on the home page to enter the radio mode. The functions of touch keys are described as below:

 : Touch it to silence the audio, touch it again to cancel.

 : Touch it to switch between stereo and mono.

 : Touch it to select frequency between FM1, FM2, and Fm3.

 : Touch it to select frequency between AM1 and Am2.

 : Touch it to preview the pre-stored stations in FM/AM bands automatically.

 : Touch it to auto seek the channels and preview the stations by sequence after stations are stored.

 : Touch it to select the previous station and play it.

 : Touch it to select the next station and play it.

 : Touch it to enter the audio setting mode. (Refer to the section "Audio Options" below for detailed operation.)

 : Touch it to return to the radio main menu from other radio menu.

 : Touch it to return to the home page from any radio menu.

DVD Operation:

Warning: Please use the original and clean disc for playing, to ensure the normal service life of the playing system. Please insert the disc with the label facing up. The disc will automatically begin playback.

1. DVD Player - DVD/VCD Disc:

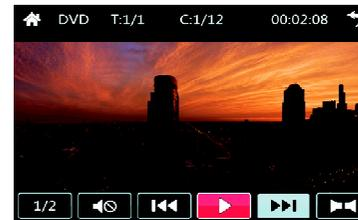

Menu 1

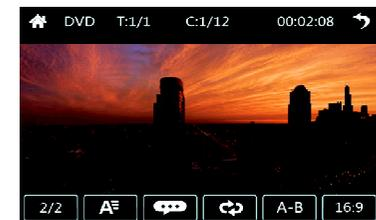

Menu 1

During playback, you can touch any place on the screen to recall the DVD play control keys menu.

(The menu appears upon some DVD/VCD discs are inserted)

These keys are described as below:

 : Touch it to display the second level of control keys (menu 2 in the figure above) of DVD.

 : Touch it to silence the audio, touch it again to cancel.

 : Touch it to select the previous track.

 : Touch it to play/pause the disk.

 : Touch it to select the next track.

 : Touch it to select sound channel between stereo, left, and right.

 : Touch it to display the first level of control keys (menu 1 in the figure above) of DVD.

-  : Touch it to select subtitle languages (only available when supplied in the disc)
-  : Touch it to enter the main directory of disc information.
-  : Touch it to select the repeat play mode between repeating the selected chapter or track, the entire track, or Off.
-  : Touch it to repeat the selected section. Touch it once to select the start point “A”, touch it a second time to select the end point “B”, the unit will play the section from A to B repeatedly. Touch it a third time to cancel and return to normal playback.
-  : Touch it to select the aspect ratio between 4:3 and 16:9.

2. DVD Player - CD/MP3 Disc:

Insert a CD/MP3 disc in any mode, the unit will enter the DVD playback mode and read the disc information, as shown in the figure below:



-  : Touch it to silence the audio, touch it again to cancel.
-  : Touch it to select the previous track.
-  : Touch it to play/pause the disk.
-  : Touch it to select the next track.
-  : Touch it to enter the disc information directory screen. (Refer to the section “DVD Player Data Disc”.)

-  : Touch it to turn on the random play mode. All the audio/video files on the current disc are played in random order. When this mode is turned off, all the audio / video files are played in normal order.
-  : Touch it to select repeat play mode, press it to select repeating the selected chapter or track, the entire track, or Off.
-  : Touch it to return to the DVD's main menu from other DVD menu.
-  : Touch it to return to the home page from any DVD menu.

3. DVD Operation Data Disc

When a data disc, including audio (MP3), video (MPEG4), picture (JPEG) encoded disc is inserted, the following media play interface will appear in the display:



-  : Touch it to display the music album tracks in MP3 or WMA format (non-video format) in the data disc. Touch a track to play it. (Refer to “DVD Operation CD / Mp3 Disc” for the interface operation.)
-  : Touch it to display the list of video files in the data disc. Touch a video file to play it. (Refer to “DVD Operation DVD VCD Disc” for the interface operation.)

 : Touch it to display the image (JPG) files in the data disc. Touch a file to access the image viewing screen. The operation method is described as below:



 : Touch it to zoom in or zoom out the picture by 2X, 3X, 4X, 1/2X, 1/3X, 1/4X, and Normal. When the picture is zoomed too large to be displayed completely on the screen, touch the four direction keys (up, down, left, and right) to adjust the position of the picture.

 : Touch it to rotate the picture clockwise or counter-clockwise.

 : Touch it to view the previous picture when in manual viewing mode.

 : Touch it to view the next picture when in manual viewing mode.

 : Touch it to select the speed of playing picture in filmstrip: High: 3 seconds --- Middle: 5 seconds ---- Low: 8 seconds.

 : Touch it to play/pause viewing picture in filmstrip.



Touch the numeric keys 0 to 9 on the screen or press the numeric buttons on the remote control to select a picture from the disc quickly to play it.

USB/SD Operation:



The operation of USB/SD playing is exactly the same as that in data disc playing. Refer to the above section "DVD Operation Data Disc".

This unit supports USB/SD playing. The USB/SD operation will not be available until a USB device or a SD card is inserted into the MiniUSB interface or the SD card slot of the unit.

When a USB device or SD card is inserted, the system will detect the device and enter the USB/SD mode. If in other play mode, touch the USB or SD icon on the home page or press the Mode key on the remote control to switch to USB/SD mode. To pull out the USB device please exit the USB/SD mode first.



Some USB/SD devices may not work with this unit, depending on the specifications of this device or the standards used by the manufacturers. Please contact your USB/SD manufacturer.

Navigation Operation:

You can insert the GPS card with navigation software preloaded into the GPS card slot of this unit, press the NAVI (GPS) key on the front panel or touch the NAVI icon on the home page to access the satellite navigation mode. Refer to the vehicle GPS navigation instruction for detailed navigation operations.

Notes:

- GPS function is available only when the GPS navigation module is installed.
- The satellite positioning function of this navigation system is achieved with the SD (TF) card loaded with electronic map navigation software. Do not pull out the GPS card while in use. If it is necessary to remove the card for upgrading, please turn off the navigation system first.

Bluetooth Operation:

This unit supports the Bluetooth Hands-free function. After the mobile phone with Bluetooth function established a point-to-point connection (paired) with this unit, you can make and receive calls or play Bluetooth music from this unit.

(The pairing password is 0000).

pairing screen, as shown in the figure below:



-  : Touch it to pair with the mobile phone.
-  : Touch it to disconnect with the mobile phone.
-  : Touch it to access the BT dialing screen, as shown in the figure below:



-  : Touch it to answer an incoming call or place an outgoing call.

-  : Touch it to end a call in progress or to reject an incoming call.
-  : Touch it to transfer audio between the head unit and mobile phone during a call.
-  : Touch it to delete the wrongly input number.
-  : Touch it to access the phone book menu of the mobile phone as shown in the figure below:



-  : Touch it to display the received calls.
-  : Touch it to display the dialed calls.
-  : Touch it to display the missed calls.
-  : Touch it to access the Bluetooth music screen, as shown in the figure below:



-  : Touch it to turn on the music player of the mobile phone and select the previous track.
-  : Touch it to turn on the music player of the mobile phone, play/pause a track

 : Touch it to turn on the music player of the mobile phone and select the next track.

 : Touch it to access the phone book menu of the mobile phone, as shown in the figure below:



 : Touch it to synchronize the phone book in the mobile phone into this unit. Select a phone number and touch it to place a call.

 : Touch it to delete the phone book.

IPOD Operation:

Touch the IPOD icon on the home page or directly insert an IPOD player the unit will access the IPOD operation mode, as shown in the figure below:



Touch the function icons on the IPOD screen to control the IPOD player and perform relevant operations. The operation of these functions is the same as in "DVD Operation CD/MP3 Disc".

TV Operation:

Touch the TV icon on the home page to enter the TV operation mode as shown in figure below:

 : Touch it to search and store channels automatically.

 : Touch it to silence the audio, touch it again to cancel.

 : Touch it to select the previous channel.

 : Touch it to select the next channel.

This unit supports various digital mobile televisions including CMM DVB-T, and ISDB. The operation method varies with the built-in digital TV of the unit. The specific operation method should be subject to the built-in digital TV of the unit.

Virtual Six-Disc Operation:

With USB device connected, insert a CD disk, the unit displays the CD playing screen, as shown in the figure below:



 : Touch it to auto load and access the virtual six-disc mode. The unit divides the USB device into six partitions and records the tracks in the CD disc into these six partitions of the USB device

by sequence. And corresponding functional operation can be performed to the content, as shown in the figure below:



-  : The No. of the six partitions and the recorded tracks are displayed at these places.
-  : Touch it to delete the recorded tracks in the entire disc.
-  : Touch it to delete the currently recorded track.

The other operations on the virtual six-disc mode are the same as those in the “DVD Player CD/MP3 Disc”!

Clock Mode Operation:

Touch the Clock icon on the home page to access the clock mode. There are several clock dials. You can touch any one of them to select one, as shown in the figure below:



Calendar Operation:

Touch the Calendar icon on the home page to access the calendar mode, as shown in the figure below:



You can adjust the date (year/month/date) in this unit, check the lunar calendar (In Chinese mode), including lunar date, lunar and calendar holidays.

To adjust the date, press the arrow icons at both sides of “year/ month/date” to adjust it.

Calculator Operation:

Touch the Calculator icon on the home page to access the calculator mode, as shown in figure the below:



Game Interface Operation:

There are multiple games in this unit from which you can obtain entertainment in traveling.

1. Jigsaw Puzzle



-  : Touch New to go into the game status.
-  : Touch Exit to exit the game.
-  : The number of games you won.
-  : The time spent in each game.

Notes:

1. Difficulty selection: three difficulty options: 3*3, 4*4, and 5*5.
2. Touch the small icons at the right side to select other puzzle picture at your own discretion.

2. Card Game

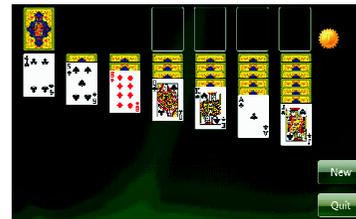

-  : Touch New to go into the game status.
-  : Touch Exit to exit the game.
-  : The number of games you won.

3. Gobang

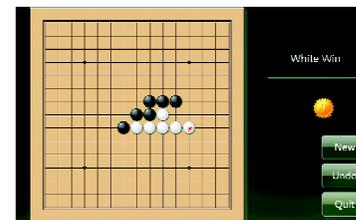

-  : Touch New to go into the game status.
-  : Touch Undo for one move back.
-  : Touch Exit to exit the game.
-  : The number of games you won.

4. Reversi

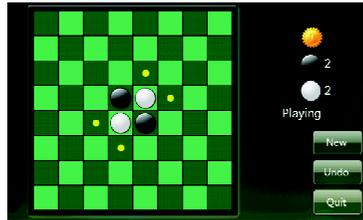

-  : Touch New to go into the game status.
-  : Touch Undo for one move back.
-  : Touch Exit to exit the game.
-  : The number of games you won.

5. Light On

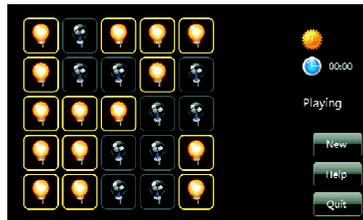

-  : Touch New to go into the game status.
-  : Touch Undo for one move back.
-  : Touch Exit to exit the game.
-  : The number of games you won.
-  : The time spent in each game.

6. Link Game



-  : Touch New to go into the game status.
-  : Touch Undo for one move back.
-  : Touch Exit to exit the game.
-  : The number of games you won.
-  : The time spent in each game.

System Setup:

Touch the Setup icon on the home page to enter the system setup menu of the unit, as shown in the figure below:



Touch the “Wallpaper”, “Startup Picture”, “General Settings”, “Display Settings”, “Audio Options”, “Video Options”, “Bluetooth Options”, “Navigation Options”, “Language Settings”, “Steering Wheel Learning”, “Date & Time”, and “About” icons on the System Setup screen to go to the corresponding setting screen.

Background Wallpaper:

Touch the Wallpaper icon on the System Setup screen to go to the wallpaper setting screen, as shown in the figure below:



  : Touch these two icons to preview the pictures back or forward. You can click your desired picture to set it as the wallpaper of this unit. There are 30 pictures in different styles are optional in the system.

User pictures : Touch this icon to go to the USB, SD, or other external devices to search your desired picture for the wallpaper.
(Image resolution: 1000*480).

Startup Picture:

Touch the Startup Picture icon on the System Setup screen, input the correct password to enter the Startup Picture setting screen.
(Password: 110001-110130).

- A. Touch the left and right arrows to preview the auto Logos or pictures.
- B. Touch the Update icon to set the current picture as the startup picture when you turn on the unit.

General Settings:

Touch the General Settings icon on the System Setup screen to enter the general setting screen.

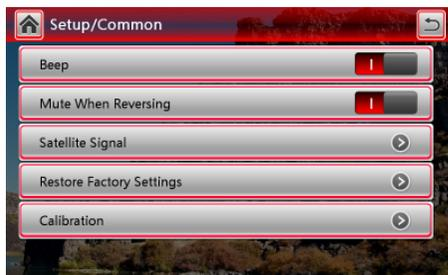

- A. Key Beep: Touch the slide block at the right side of this option to turn on or off the key tone.
- B. USB Storage Device: Touch the slide block at the right side of this option to select the previous or the next USB device.
- C. Mute when in reverse: Touch the slide block at the right side of this option to turn on or off the sound when in reverse.
- D. Restore Factory Settings: Touch this option to confirm or cancel restoring factory settings.

E. Touch Screen Calibration: Touch this option, the system displays "Are you sure to calibrate?" Select OK to enter the touch screen calibration interface. The calibration steps are shown in figure below:

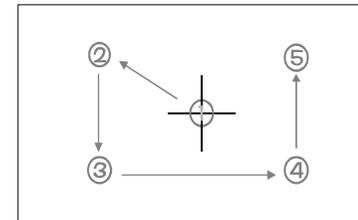

If deviation of the touch position occurs, you can go to the touch screen coordinate to calibrate it. Click "+" on the screen, "+" will move to the four corners on the screen one by one. Please aim at the center position of "+" when calibrating. When the center position and the corners are calibrated, touch the screen again, the system exits the screen calibration mode. If the screen calibration failed, the system will ask you to calibrate it again by the steps shown in the figure above.



With the unit on, long press NAVI(GPS) or MENU on the front panel, the system will enter the screen calibration mode automatically!

Display Settings:

- A. Daytime brightness: Press the button to adjust to your desired brightness in daytime.
- B. Night brightness: Press the button to adjust to your desired brightness at night.
- C. Headlamp auto detection: Touch the slider block at the right side of this option to select turning on or off the function of switching between day & night modes according to the On/Off condition of the headlamp.

D. Time for entering screen saver: Touch the arrow at the right side of this option to specify a time before entering the screen saver mode between Never, 15 Seconds, 30 Seconds, and 60 Seconds.

Audio Options:

Touch the Audio Options icon on the System Setup screen to enter the audio settings mode. Touch the slider block at the right side to select Original Sound, Pop, Rock, Jazz, Classic, Soft, and Custom as required. As shown in the figure below:

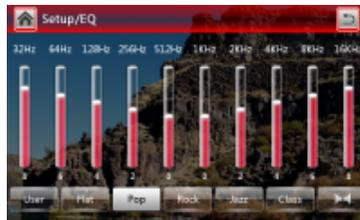

If you are not satisfied with the sound effect offered by the system, you can define your own sound effect by touching the column bar of “Bass”, “Mid”, “Treble”, “Low Frequency”, “Intermediate Frequency”, and “High Frequency”.

: Touch it to enter the four-channel balance setting screen, as shown in the figure below:

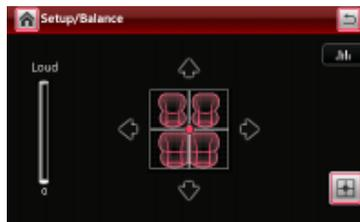

Touch the L or R icons to adjust the volume attenuation of the left or right speaker.

Touch the F and B icons to adjust the volume attenuation of the front or back speaker.

: Touch it to restore the front/back/left/right channels to the default settings. You can slide the column bar to define the loudness.

: Touch it to enter the audio settings mode.

Video Options:

Touch the Video Options icon on the System Setup screen to enter the video settings screen.

A. Not View Video While Driving: Touch the slider block at the right side of this option to select viewing or not viewing video or picture while driving. For your safety, it is highly recommended to activate this function.

B. Color Temperature Options: Touch the arrow at the right side of this option to select overall color scheme of DVD video player between “Cool”, “Standard”, and “Warm”.

Bluetooth Options:

Touch the Bluetooth Options icon on the System Setup screen to enter the Bluetooth settings screen.

A. Device Name: The name of the Bluetooth device of this unit.

B. Pairing Password: Touch the arrow icon at the right side of this option to enter and set the pairing password. Default password is “0000”.

C. Auto Connection: Touch the slider block at the right side of this option to select connecting or not connecting the device the last time connected automatically.

D. Auto Answer: Touch the slider block at the right side of this option to select automatically answer or reject incoming calls in the Bluetooth mode.

Navigation Options:

Touch the Navigation Options icon on the System Setup screen to enter the navigation options screen.

- A. Navigation Audio Gain: Drag the slider block at the right side of this option to adjust the navigation volume.
- B. Navigation Background Sound: Drag the slider block at the right side of this option to adjust the background sound in the navigation mode with the range between 0%~99%.
- C. Navigation Monitor: Drag the slider block at the right side of this option to turn on or off the navigation monitor function. When this function is activated, the GPS voice can be added into other modes and voice of other modes can be added into the GPS mode. Otherwise, GPS voice can only be heard in GPS mode.
- D. Automatically Enter Navigation upon Power-on: Drag the slider block at the right side of this option to turn on or off the function of automatically entering the navigation mode upon power on.
- E. Navigation Route: Touch the arrow icon at the right side of this option to select the correct route in the searched results.
- F. GPS Reset: Touch the arrow icon at the right side of this option to select resetting or not resetting GPS. User might also be required to select the navigation system initialization.

Language Settings:

Touch the Language Settings icon on the System Setup screen to enter the language settings screen.

Touch the language icons to select the language between Chinese (Simplified/Traditional), English, and other languages. User can pre-set the language according to the need and actual situation this unit supports languages of multiple countries and regions.

Steering Wheel Learning:

This function can be achieved when the following conditions are met:

- A. The steering wheel key setting is applicable to the steering wheel of the vehicle which is not controlled by bus mode.

- B. The steering wheel of vehicle must be controlled by voltage input control mode, that is, when operate each key, different voltage value is inputted to the corresponding input end of the vehicle stereo.
- C. Before installation, find the GND wire, key control wire (some vehicles has two) of the vehicle first, and then connect them with the steering wheel wire supplied with this unit
(When connecting key control wire, please connect key control wire No. 1 first, if key control is abnormality, then select key control wire No. 2 and set the function of steering wheel keys again before using).

Touch the Steering Wheel Learning icon on the System Setup screen to enter the steering wheel key settings screen, as shown in the figure below:



To set the functions of the steering wheel keys, press the key function that you want to set on the screen first, the key flashes. Then press the key on the steering wheel that you want to set as this function and release when a beep tone is heard. The setting is completed. Then you can continue with setting the next function key with the same steps repeatedly till all the keys are set. In this way you can learn all steering wheel keys and achieve corresponding function.



The keys in red are not set with the functions. The green ones are already set. The key flashing in red and green is during the process of learning!

Date & Time:

Touch the Date & Time icon on the System Setup screen to enter the date and time settings screen.

You can adjust the date (year/month/date) and time (hour and minute) displayed on this unit, as shown in the figure below:



- A. Adjust date: Touch or slide the numbers at year/month/date to adjust the date displayed on this unit.
- B. Adjust clock: Touch or slide the numbers at hour/minute to adjust time displayed on this unit.
- C. GPS Time: Touch this icon to update the time and synchronize it with the time of the GPS satellite.
- D. OK: Touch this icon to save the adjusted date and time (year/month/date/hour/minute)
- E. GTM***: Touch this icon to enter the time zone settings screen. You can select the proper time zone as required. (For example, select GTM +8:00 for China.)

About Unit:

Touch the About Unit icon on the System Setup screen to enter the version information screen on which the version information of the product software can be viewed.



Products of this company are constantly changing or upgrading. The version information is subject to your actual purchased product. Thank you!

Troubleshooting:

Problem	Cause	Action
Unit will not turn on	Power supply fuse blown	Replace fuse
	Incorrect CPU processing caused by other reason	Press the RES key on the front panel with a pencil point to reset and restart the unit.
Remote control does not work	Low battery power	Replace new battery
	Battery mounted wrong/battery's insulating piece not removed	Mount battery correctly/remove the insulating piece.
Touch keys in disorder	Data loss due to disoperation	Calibrate the touch precision as per the instruction on page 24 of this manual.
	Touch precision affected by temperature and other factors	
No image when playing disc	Incorrect connection of brake line	Check and connect brake line correctly.
	Not in braking state	Park the vehicle in a safe place and put on the brake
Poor image and audio quality in TV mode	Wrong TV system	Switch to local TV system
	Weak signal	Move to a place with strong signal.
Screen stretched or narrowed	Incorrect screen aspect ratio setting	Use correct screen aspect ratio
Weak radio signal/noise/less channels can be received	Auto antenna not stretched out	Check and connect auto antenna control line correctly.
	Antenna amplifier not power on, LOC is turned on	Connect the power supply line of antenna amplifier and turn off LOC.
Unit will not read SD/USB (can be read on computer)	Problem of SD/USB brand compatibility, some cards may incompatible with this unit.	Replace compatible SD card or USB.
Unit will not accept a disc	Already has disc inside the unit	Eject the existing disc and insert the new disc again.
Cannot change subtitle language	Only one language burned in the disc	Disc with only one language cannot change language
Unit will not play disc normally	Scratched disc	Replace disk
	Laser head on the mechanism is dirty.	Clean the laser head with special cleaning disc
No sound output or low volume	Incorrect wire connection, speaker bad	Check and connect wire correctly, replace speaker
	Low volume, balance setting offset large	Turn up volume, set balance at the middle position

Performance Parameters:

Specifications

Operating voltage: DC +12V

Operating voltage range: 10.8V-16V

Max operating current: 10A

Angle of installation: Front and back tilt less than 300

DVD/CD PLAYER

Compatible disc: DVD-R, DVD-RW, DVD+R, DVD+RW, CD-R, CD-RW, CD-DA, Mp3, WMA, HDCD, SVCD, VCD, MPEG, JPEG, DIVX

Audio S/N ratio: 85dBu

Dynamic range: 95dBu

Frequency response: 20Hz-20KHz

Digital audio sample: 24bit

ESP: DVD 23 secs

CD-DA: 10 secs

Mp3: 100 secs

WMA: 200 secs

Mechanic anti-vibration: 10-200Hz: X/Y/Z: 1.0G

Power output: 45W*4 impedance 4 ohms

SNR: 70dBu

Video

System: NTSC, PAL (automatic identification)

Output: 1Vp-p (75 ohms)

Input: 1Vp-p (75 ohms)

FM Tuner

Tuning range: 87.5MHz-108.0MHz

Sensitivity: -30dB: 15dB

SNR: -50dB: 60dB

Frequency response: 30Hz-15KHz(3dB)

AM Tuner

Tuning range: 522kHz-1620kHz

Sensitivity: SN=20dB: 20dBu

Image rejection: 60dB