

Typ 2 509 04

Škoda Fabia II. RS 09/2010 →

Spoilerecken • Rozšíření předního nárazníku
Front spoiler edges or • Coins spoiler avant ou

Milotec[®]
AUTO-EXTRAS

Montageanleitung
Montážní návod
Fitting instructions
Instructions de montage

ATEST
8 SD
1951

Návod uschovejte
pro účely kontroly a STK!

Technische Änderungen vorbehalten
Technická změna vyhrazena
Subject to technical alterations
Sous réserves de modifications techniques

Lieferumfang • Obsah balení • The pack contains • Fournitures:

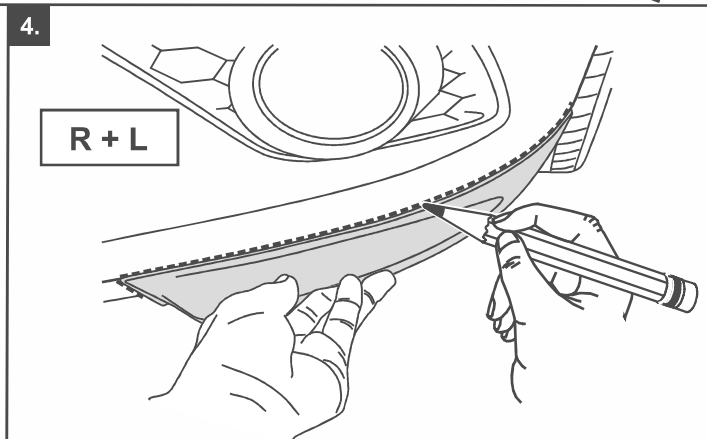
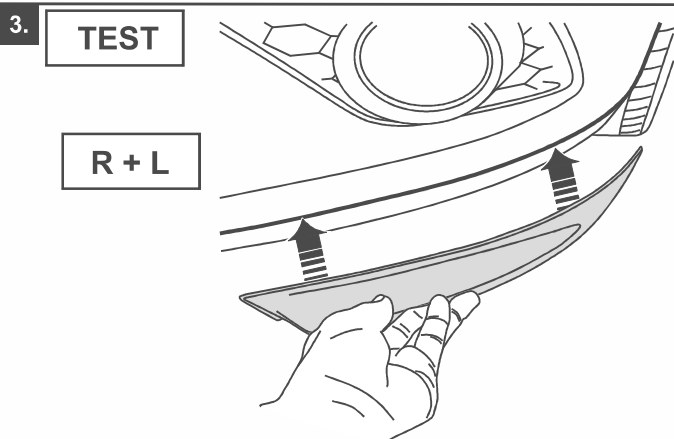
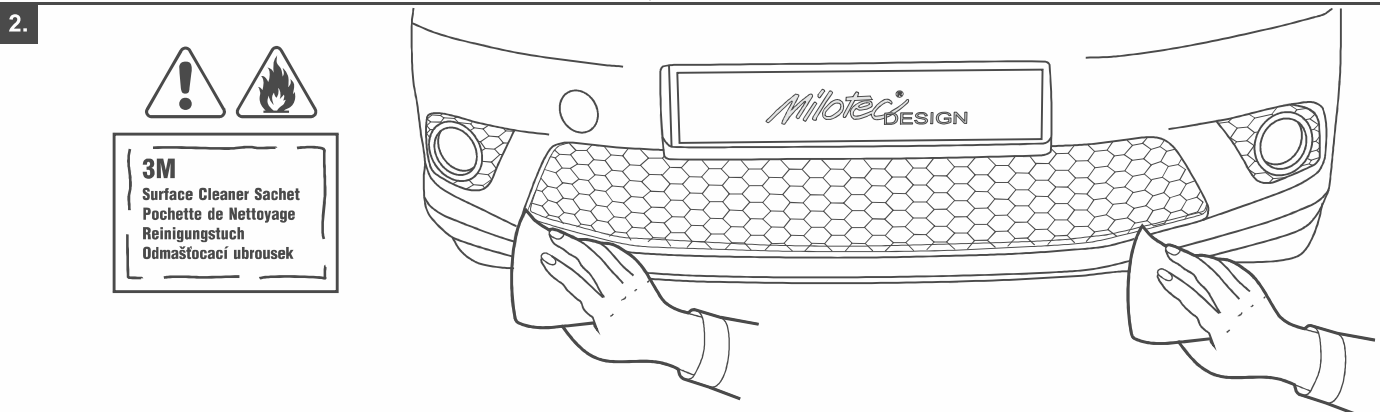
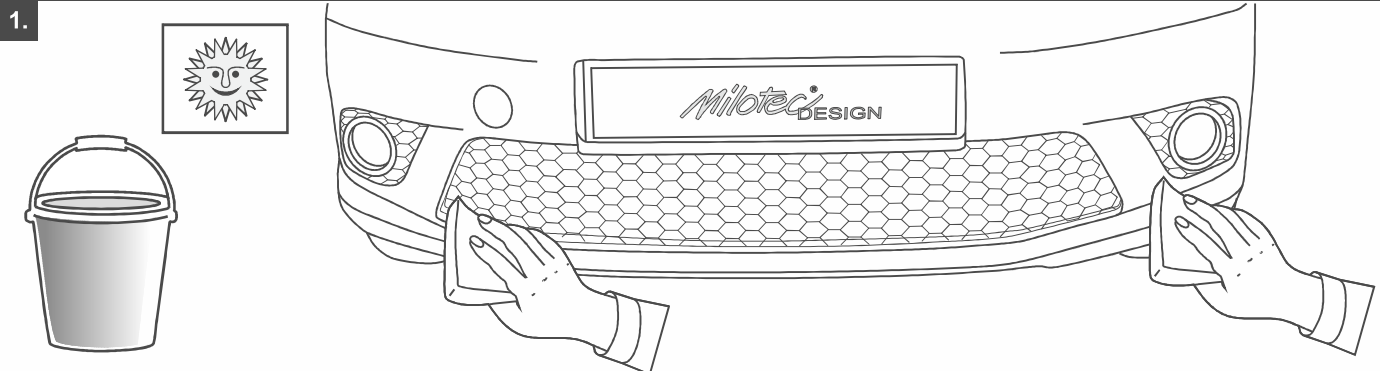
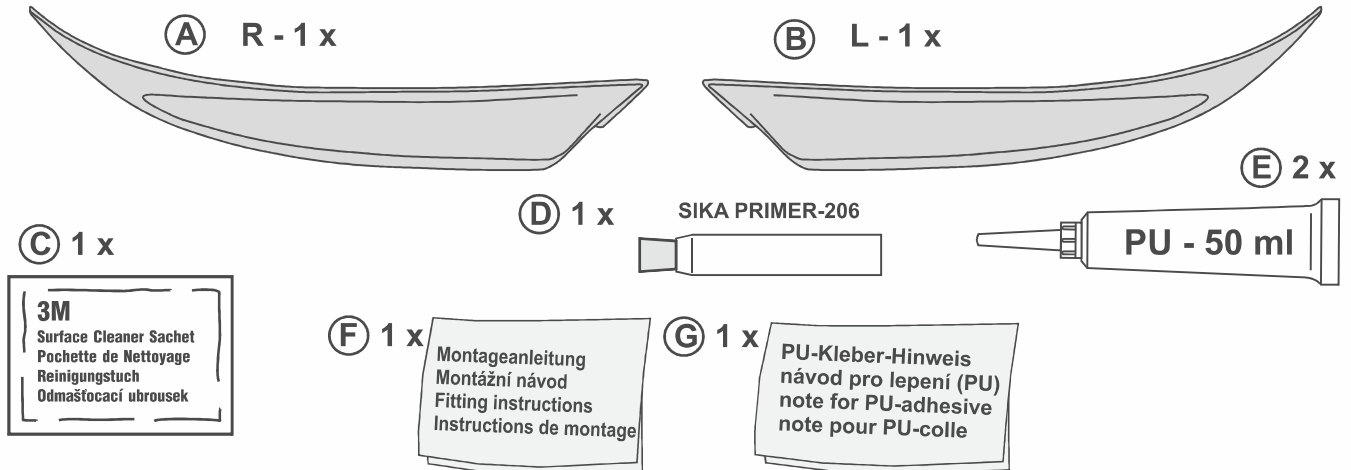

5.

R + L



3M
Surface Cleaner Sachet
Pochette de Nettoyage
Reinigungstuch
Odmašťovací ubrousek

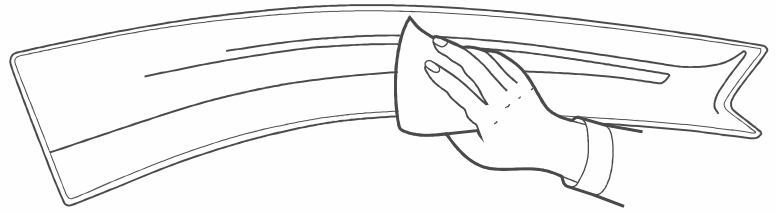

6.

R + L

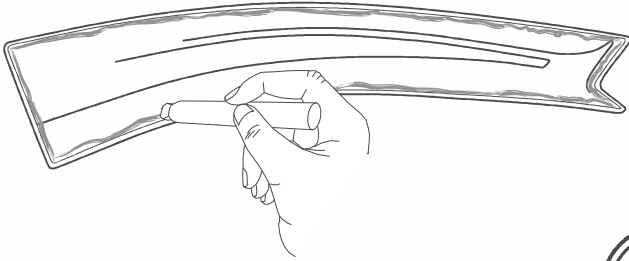

7.

R + L

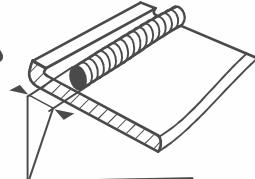

Ø 4 mm

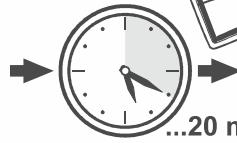
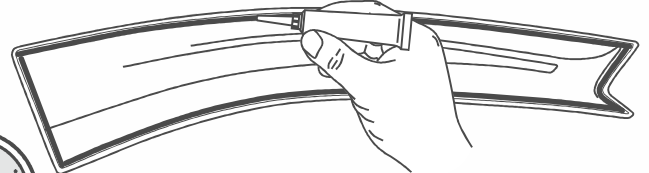

...20 min.

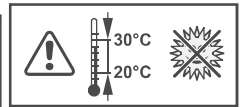
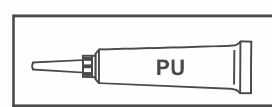
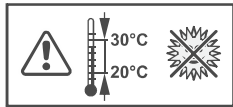

8.

R + L

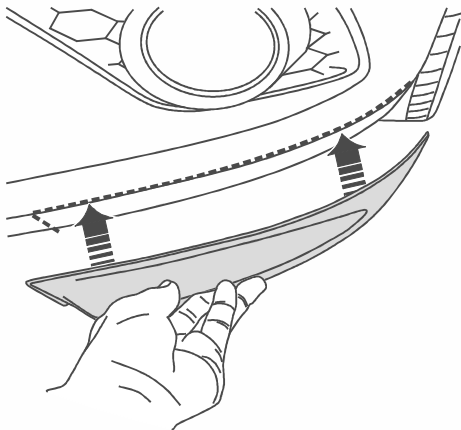

9.

R + L

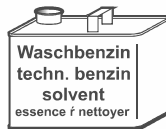
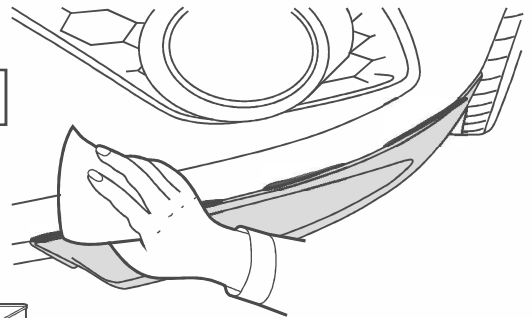

10.

R + L

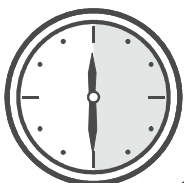

... 6h

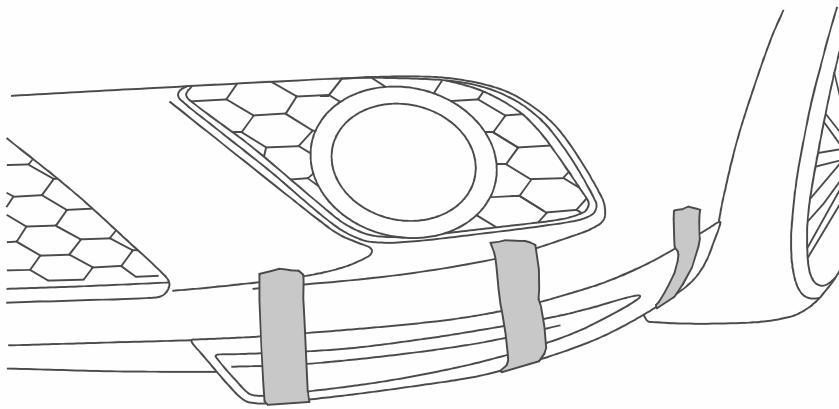

11.

